

GINEBRA

INSTALLATION

1,5 h



2 opérateurs



1,50 x 0,90 m

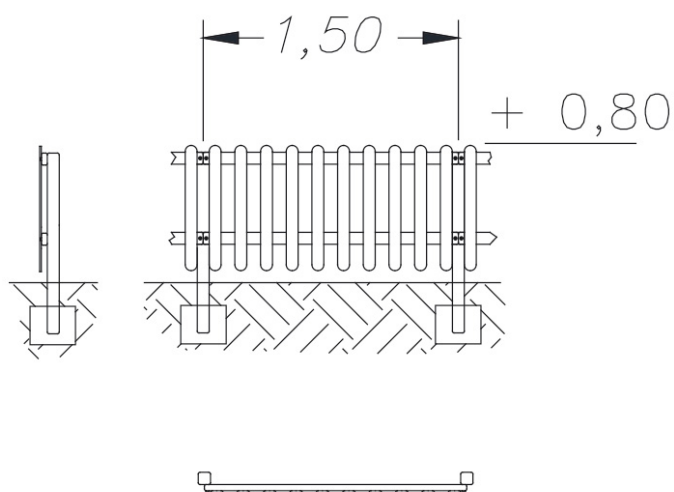

45 kg / 45 kg

DONNÉES TECHNIQUES

JOLAS se réserve le droit de modifier sans préavis les informations contenues dans le présent.