

## GINEBRA



### INSTALAZIOA



1,5 h



2 operadore



1,50 x 0,80 m



45 kg / 45 kg

### DATU TEKNIKOAK

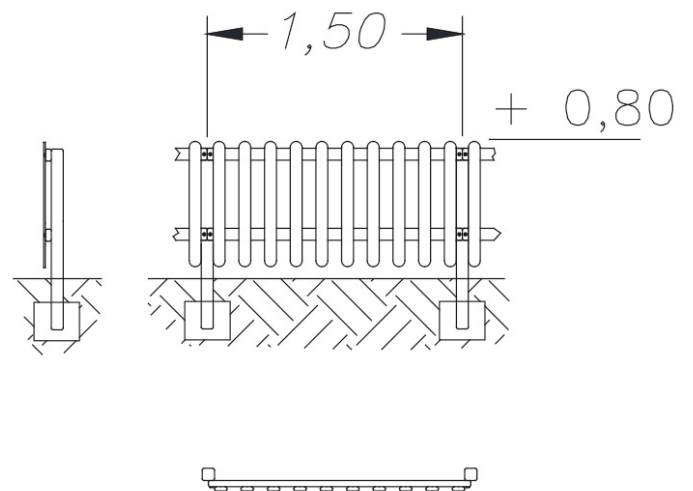

JOLAS-ek dokumentu honetan jasotako informazioa aldez aurretik abisatu gabe aldatzeko eskubidea gordetzen du.